

# RECYFIX® STANDARD

**ENVIRONMENTALLY FRIENDLY DRAINAGE.**

FOR DOMESTIC APPLICATIONS AND PEDESTRIAN AREAS.

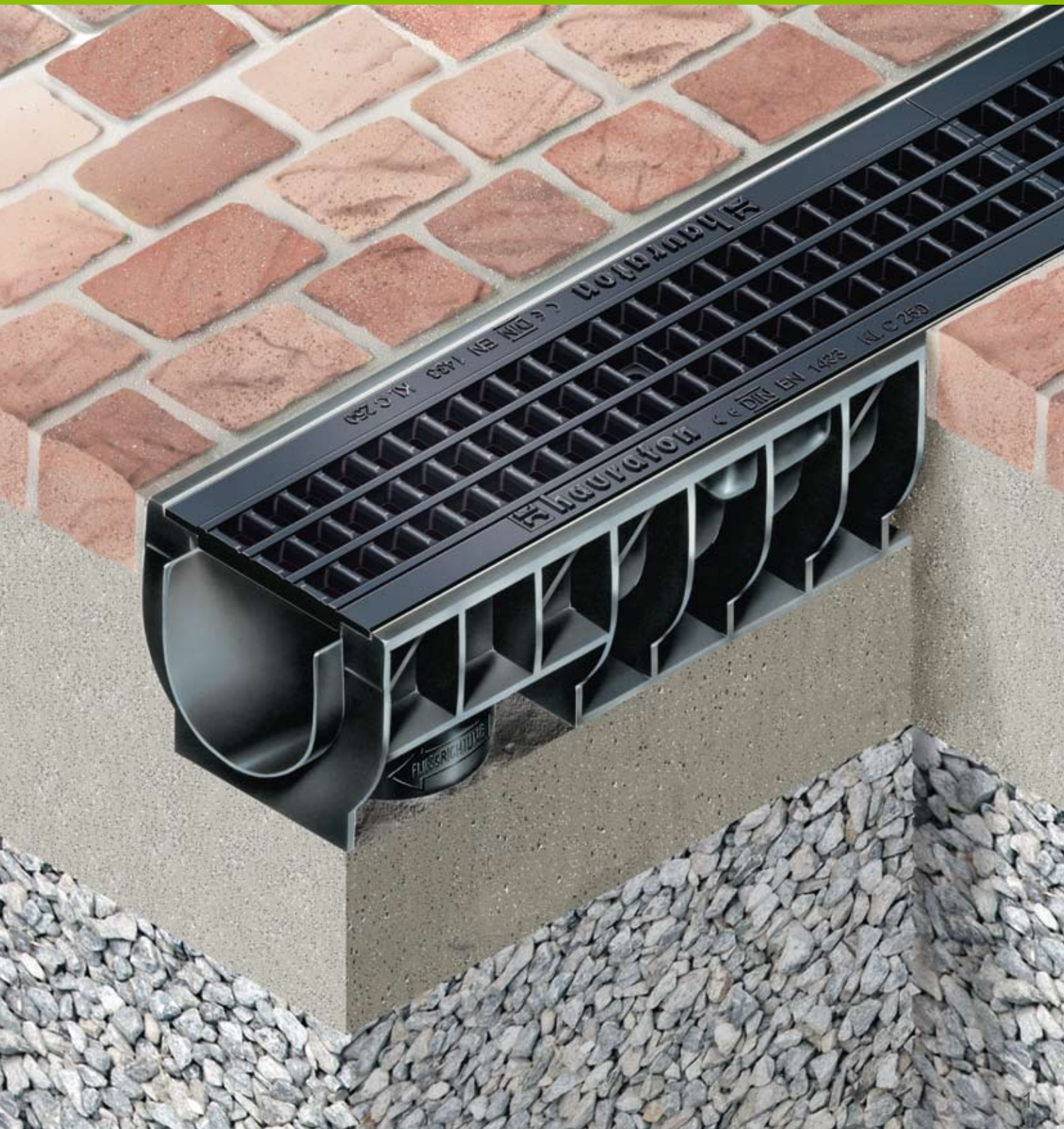

## AT A GLANCE

- ✓ Easy and fast to install
- ✓ For domestic applications up to load class C 250
- ✓ Strength and function comply with DIN EN 1433



# RECYFIX® STANDARD

**ENVIRONMENTALLY FRIENDLY DRAINAGE.**  
FOR DOMESTIC APPLICATIONS AND PEDESTRIAN AREAS.

## THE ECOLOGICAL INNOVATION

RECYFIX STANDARD channels consist of 100% pure recycled polyolefin plastics. They can be integrated into the ecological material cycle and are 100% recyclable. Green light for the environment! Because of their low weight, RECYFIX STANDARD channels are easy to transport and install. Nevertheless, in functionality and strength the system compares well with all conventional channel systems - a fact that has been proven in practice.

## HIGH-TECH DEVELOPMENT

RECYFIX STANDARD channels have been developed in cooperation with a well-known research institute for plastic recycling. With the help of computer simulation it was possible to create a highly rigid construction with torsion-free ribs, which weighs significantly less than conventional channels made of mineral-based materials but has equally good performance characteristics and durability.

## APPLICATION AREAS

- primarily private areas
- garage entrances
- yards
- terraces
- gardens
- parks

## CHARACTERISTICS

- made of PE-PP
- up to load class C 250
- pre-formed vertical and lateral connections
- complies with DIN EN 1433

## PRODUCT RANGE

- Trash boxes
- End caps
- Foul air traps
- Locking handles
- GUGI ductile iron mesh gratings
- Ductile iron gratings
- Slotted gratings
- Mesh gratings
- Perforated gratings
- Closed covers



## RECYCLED PE-PP MATERIAL

RECYFIX STANDARD channels consist of 100% pure recycled polyolefin plastics. The material is characterised by its high chemical resistance, resistance to frost and salt, it is UV-stabilised, environmentally neutral and leakproof.

## DIN EN 1433

All RECYFIX STANDARD channels meet the requirements of the European standard DIN EN 1433. The products carry the CE-mark.

## A COMPREHENSIVE SYSTEM

RECYFIX STANDARD channels are available in different heights and nominal widths. Canal connections are possible at the bottom, on the sides or ends. A choice of channel gratings is available to suit different surface finishes and load applications. The system is rounded off with end caps, foul air locks for vertical outlet and trash boxes with mud bucket - optionally with internal foul air trap. To achieve safety under the exposure to traffic the channel gratings are locked to the base segment.



It is very easy to cut RECYFIX STANDARD channels on site - e.g. mitred cuts, corner joints and channels cut to length.



CASTRIES, Médiathèque, France

RECYFIX®  
PLUS

RECYFIX®  
STANDARD

SLOTTED  
CHANNELS

FASERFIX®  
STANDARD

RECYFIX®POINT  
FASERFIX®POINT

DACHFIX®

RECYFIX®  
GREEN SUPER

RECYFIX®  
GREEN STANDARD



RECYFIX®  
STREIF

LINEFIX®

# RECYFIX® STANDARD

**ENVIRONMENTALLY FRIENDLY DRAINAGE.**  
FOR DOMESTIC APPLICATIONS AND PEDESTRIAN AREAS.

RECYFIX STANDARD channels meet the requirements of DIN EN 1433 and are suitable for the following loading capacities:

-  **CATEGORY A 15,**  
**LOAD CLASS 15 KN**
-  **CATEGORY B 125,**  
**LOAD CLASS 125 KN**
-  **CATEGORY C 250,**  
**LOAD CLASS 250 KN**

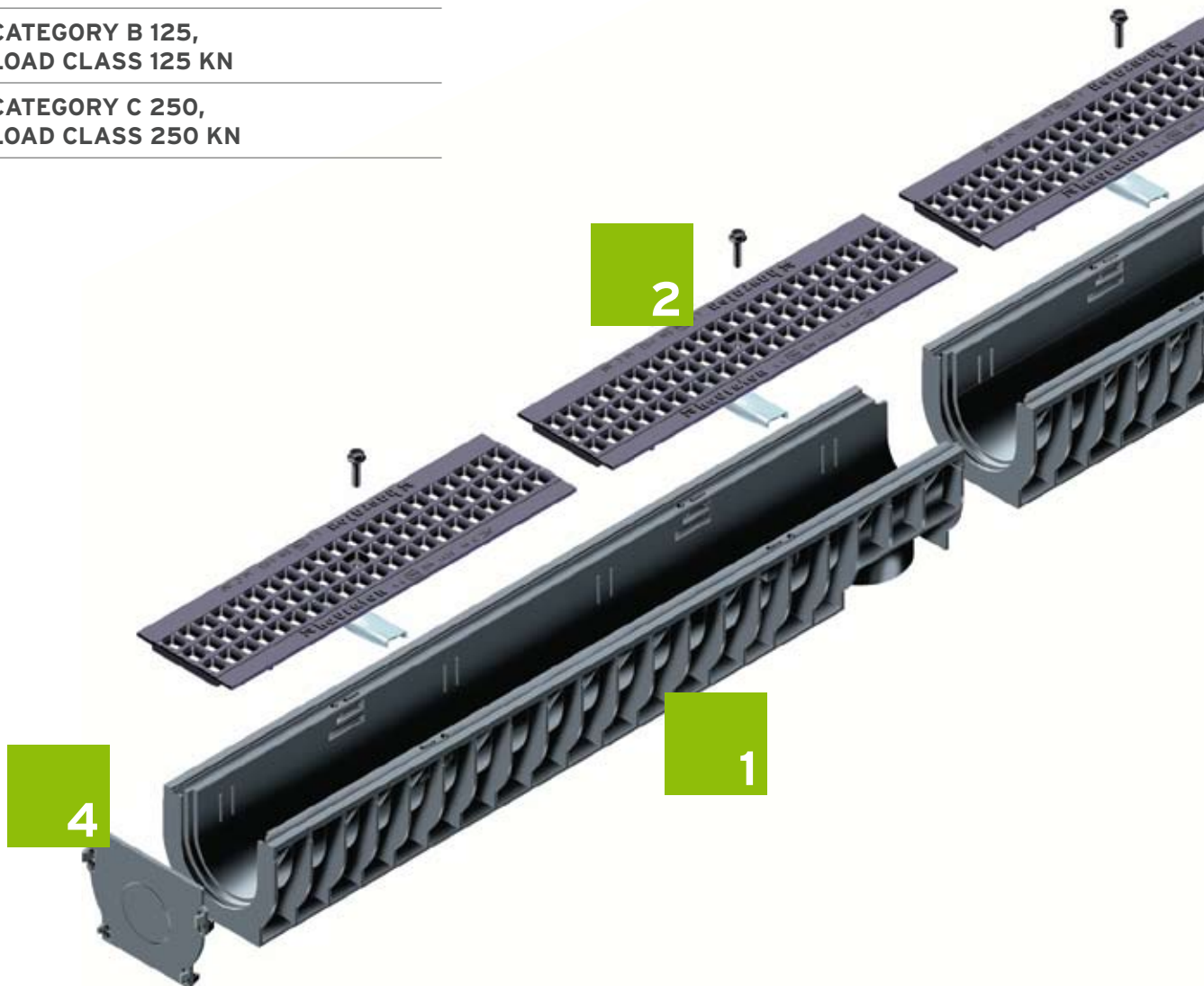

## GRATING OPTIONS FOR RECYFIX STANDARD CHANNELS

GUGI-Ductile iron mesh gratings*	Ductile iron gratings*	Slotted gratings*	Steel mesh gratings*
----------------------------------	------------------------	-------------------	----------------------

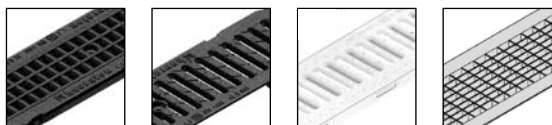

Loading capacities as per DIN EN 1433 suitable for passenger car traffic				
<b>B 125</b>			100	100
<b>C 250</b>	100, 150, 200, 300	100, 200		100, 150, 200

\* nominal width

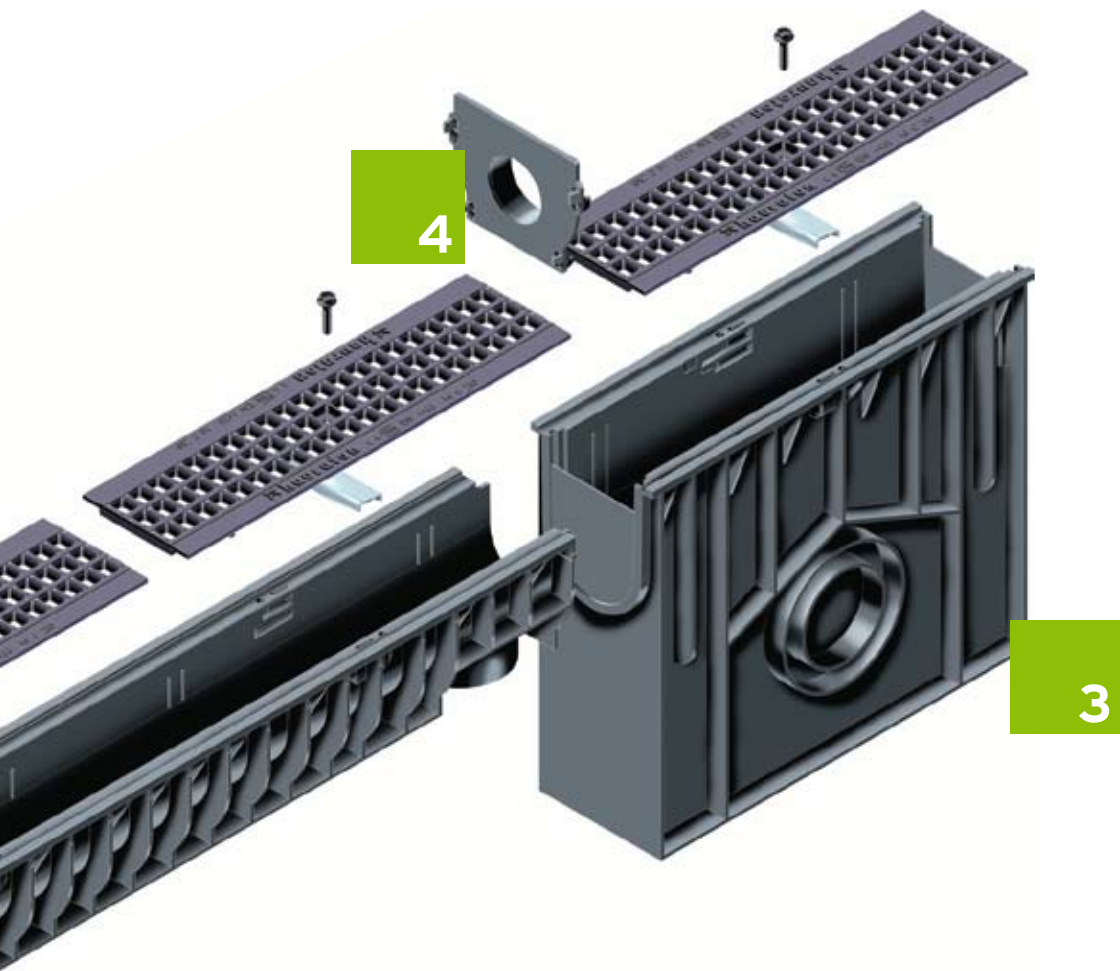

**1**

■ Channels made of PE-PP, according DIN V 19580 / EN 1433, CE-conform, with tongue and groove connection for exact installation

**2**

■ numerous grating options, for example GUGI-Ductile iron mesh gratings

**3**

■ Trash box with pipe-connection possibilities

**4**

■ end caps with and without outlets

LINEFIX®	RECYFIX® STREIF	RECYFIX® GREEN STANDARD	RECYFIX® GREEN SUPER	DACHFIX®	RECYFIX®POINT FASERFIX®POINT	FASERFIX® STANDARD	SLOTTED CHANNELS	RECYFIX® STANDARD	RECYFIX® PLUS
----------	-----------------	-------------------------	----------------------	----------	------------------------------	--------------------	------------------	-------------------	---------------

# RECYFIX® STANDARD 100

## RECYFIX® STANDARD 100 - Combi article, class A 15

Type 80 with perforated grating, stainless steel, locked\*

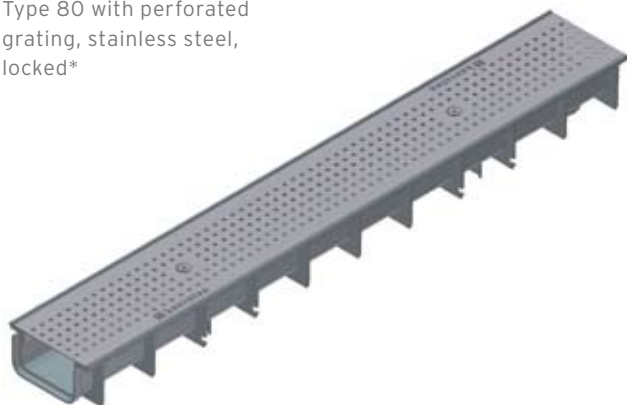

Type 010 with perforated grating, stainless steel, locked

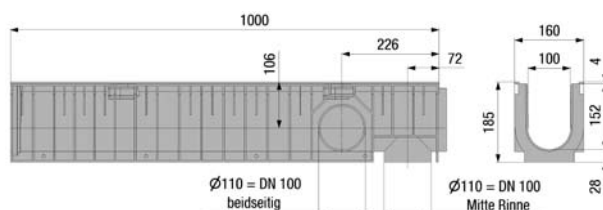
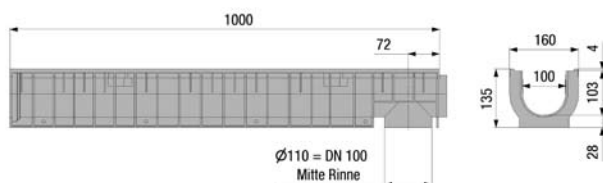
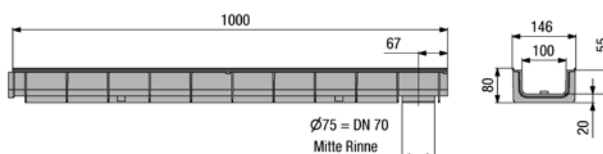
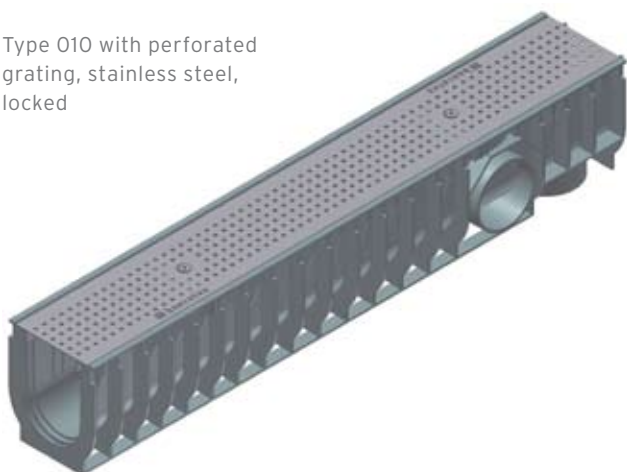

	Length mm	Width mm	Height mm	Drainage cross- sect. cm <sup>2</sup>	Intake cross- sect. cm <sup>2</sup> /m	Weight kg	Article No. galvanised	Article No. stainless steel
Type 60 with perforated grating, stainless steel, locked*	1000	146	60	25	161	2,9	-	41244
Type 80 with perforated grating, stainless steel, locked*	1000	146	80	45	161	3,1	-	41246
Type 01 with perforated grating, stainless steel, locked	1000	160	135	92	161	4,5	-	41240
Type 010 with perforated grating, stainless steel, locked	1000	160	185	142	161	5,4	-	41242
Type 0105 with perforated grating, stainless steel, locked	500	160	135	92	161	2,3	-	41247
Type 01005 with perforated grating, stainless steel, locked	500	160	185	142	161	2,7	-	41248

# RECYFIX® STANDARD 100

## RECYFIX® STANDARD 100 - Combi article, car traffic

Type 60 with slotted grating  
SW 75/9, locked\*

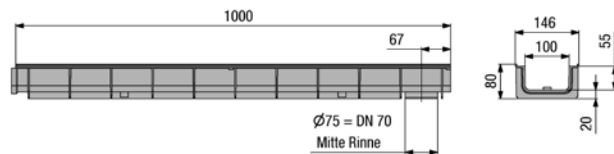
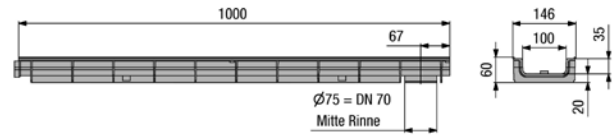

Type 01 with slotted grating  
SW 75/9, locked

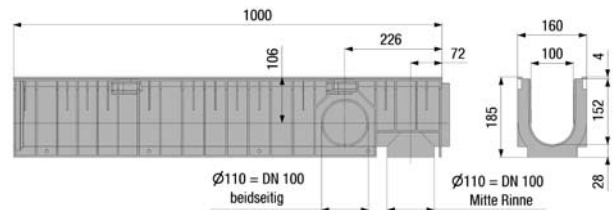
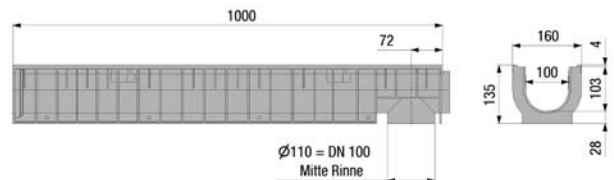
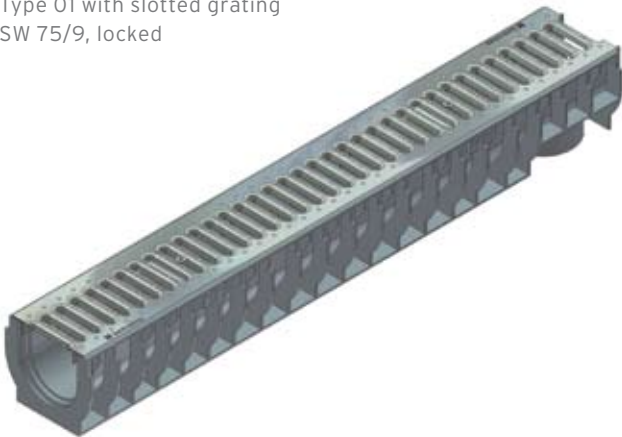

	Length mm	Width mm	Height mm	Drainage cross- sect. cm <sup>2</sup>	Intake cross- sect. cm <sup>2</sup> /m	Weight kg	Article No. galvanised	Article No. stainless steel
Type 60 with slotted grating SW 75/9, locked*	1000	146	60	25	280	3,0	40236	41204
Type 80 with slotted grating SW 75/9, locked*	1000	146	80	45	280	3,1	40246	41206
Type 60 with mesh grating MW 30/10, locked*	1000	146	60	25	650	4,2	40237	41214
Type 80 with mesh grating MW 30/10, locked*	1000	146	80	45	650	4,3	40247	41216
Type 01 with slotted grating SW 75/9, locked	1000	160	135	92	280	4,4	40231	41200
Type 0105 with slotted grating SW 75/9, locked	500	160	135	92	280	2,2	40261	41207
Type 010 with slotted grating SW 75/9, locked	1000	160	185	142	280	5,3	40296	41202
Type 01005 with slotted grating SW 75/9, locked	500	160	185	142	280	2,6	40266	41208
Type 01 with mesh grating MW 30/10, locked	1000	160	135	92	650	5,2	40232	41210
Type 0105 with mesh grating MW 30/10, locked	500	160	135	92	650	2,6	40262	41217
Type 010 with mesh grating MW 30/10, locked	1000	160	185	142	650	6,6	40297	41212
Type 01005 with mesh grating MW 30/10, locked	500	160	185	142	650	3,2	40267	41218

The quality of the stainless steel material is according CNS 1.4301.

RECYFIX®  
PLUS

RECYFIX®  
STANDARD

SLOTTED  
CAHNNELS

FASERFIX®  
STANDARD

RECYFIX®POINT  
FASERFIX®POINT

DACHFIX®

RECYFIX®  
GREEN SUPER

RECYFIX®  
GREEN STANDARD

RECYFIX®  
STREIF

LINEFIX®



# RECYFIX® STANDARD 100

## RECYFIX® STANDARD 100 - Combi article, class B 125

Type 80 with mesh grating  
MW 30/10, galvanised,  
locked\*

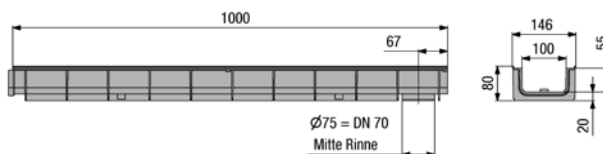
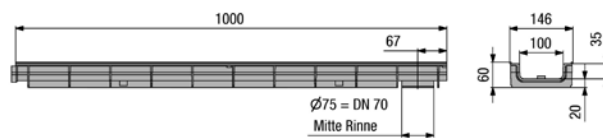

Type 010 with mesh grating  
MW 30/10, galvanised,  
locked

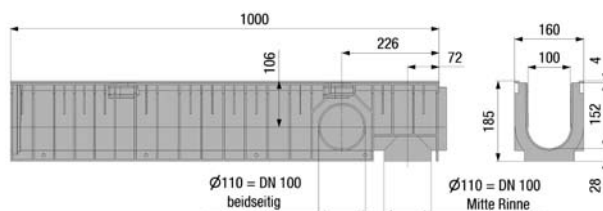
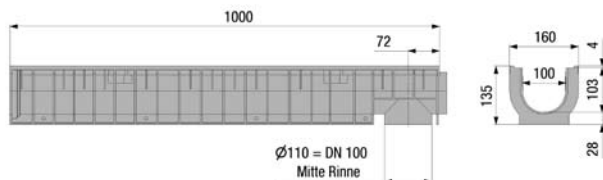

	Length mm	Width mm	Height mm	Drainage cross- sect. cm <sup>2</sup>	Intake cross- sect. cm <sup>2</sup> /m	Weight kg	Article No.
Type 60 with mesh grating MW 30/10, galvanised, locked*	1000	146	60	25	650	5,0	41224
Type 80 with mesh grating MW 30/10, galvanised, locked*	1000	146	80	45	650	5,1	41226
Type 01 with mesh grating MW 30/10, galvanised, locked	1000	160	135	92	650	5,2	41220
Type 0105 with mesh grating MW 30/10, galvanised, locked	500	160	135	92	650	3,4	41227
Type 010 with mesh grating MW 30/10, galvanised, locked	1000	160	185	142	650	6,6	41222
Type 01005 with mesh grating MW 30/10, galvanised, locked	500	160	185	142	650	3,8	41228

\* For common frequented areas we recommend FASERFIX SUPER KS channels, flat (catalogue CIVILS).

# RECYFIX® STANDARD 100

## RECYFIX® STANDARD 100 - Combi article, class C 250

Type 80 with GUGI-Ductile iron mesh grating MW 20/30, black, locked\*

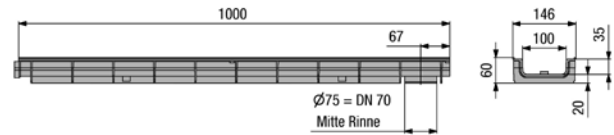

Type 01 with ductile iron grating SW 80/14, black, locked

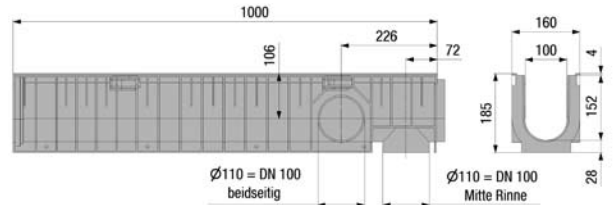
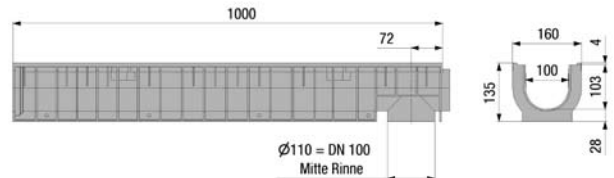
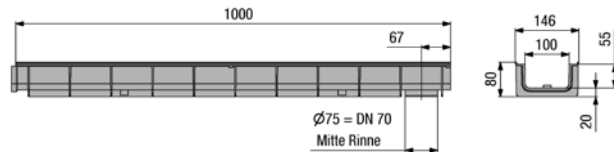
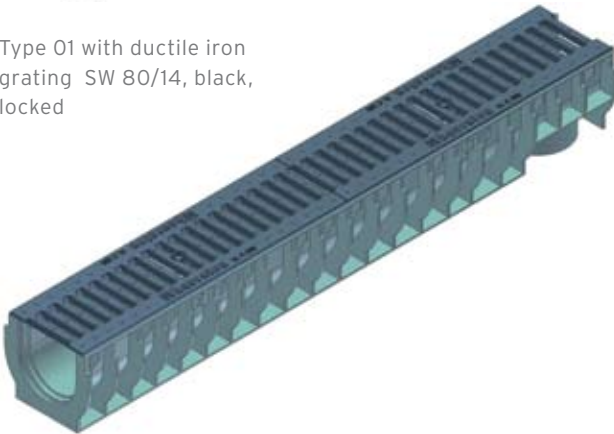

	Length mm	Width mm	Height mm	Drainage cross- sect. cm <sup>2</sup>	Intake cross- sect. cm <sup>2</sup> /m	Weight kg	Article No.
Type 60 with GUGI-Ductile iron mesh grating MW 20/30, black, locked*	1000	146	60	25	444	5,4	40239
Type 80 with GUGI-Ductile iron mesh grating MW 20/30, black, locked*	1000	146	80	45	444	5,5	40253
Type 60 with ductile iron grating SW 80/14, black, locked*	1000	146	60	25	450	5,8	40238
Type 60 with ductile iron grating, black, SW 6 mm, with locking device*	1000	146	60	25	290	7,6	41234
Type 80 with ductile iron gating SW 80/14, black, locked*	1000	146	80	45	450	5,9	40248
Type 80 with ductile iron grating, black, SW 6 mm, with locking device*	1000	146	80	45	290	7,7	41236
Type 01 with GUGI-Ductile iron mesh grating MW 20/30, black, locked	1000	160	135	92	449	7,7	40234
Type 0105 with GUGI-Ductile iron mesh grating MW 20/30, black, locked	500	160	135	92	444	3,8	40264
Type 010 with GUGI-Ductile iron mesh grating MW 20/30, black, locked	1000	160	185	142	444	8,6	40299
Type 01005 with GUGI-Ductile iron mesh grating MW 20/30, black, locked	500	160	185	142	444	4,2	40269
Type 01 with ductile iron grating SW 80/14, black, locked	1000	160	135	92	450	8,2	40233
Type 01 with ductile iron grating, SW 6 mm, locked	1000	160	135	92	290	9,2	41230
Type 0105 with ductile iron grating SW 80/14, black, locked	500	160	135	92	450	4,1	40263
Type 0105 with ductile iron grating, black, SW 6 mm, locked	500	160	135	92	290	4,6	41237
Type 010 with ductile iron grating SW 80/14, black, locked	1000	160	185	142	450	9,1	40298
Type 010 with ductile iron grating, SW 6 mm, locked	1000	160	185	142	290	10,1	41232
Type 01005 with ductile iron grating SW 80/14, black, locked	500	160	185	142	450	4,5	40268
Type 01005 with ductile iron grating, black, SW 6 mm, locked	500	160	185	142	290	5,0	41238

\* For common frequented areas we recommend FASERFIX SUPER KS channels, flat (catalogue CIVILS).

RECYFIX® PLUS

RECYFIX® STANDARD

SLOTTED CHANNELS

FASERFIX® STANDARD

RECYFIX® POINT FASERFIX® POINT

DACHFIX®

RECYFIX® GREEN SUPER

RECYFIX® GREEN STANDARD

RECYFIX® STREIF

LINEFIX®

# RECYFIX® STANDARD 100

## RECYFIX® STANDARD 100 - Accessories



Trash box with plastic bucket, slotted grating, SW 75/9, trafficable, locked



Trash box with plastic bucket, ductile iron grating SW 80/14, black, class C 250, locked

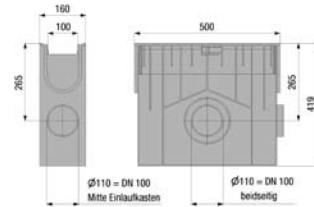

Foul air trap, vertical, DN 100



Foul air trap DN 100, inside



End cap combined made of PE-PP with outlet DN 70, type 01

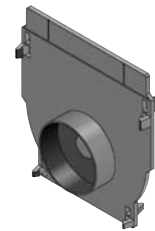

End cap combined made of PE-PP with outlet DN 70, type 010

	Length mm	Width mm	Height mm	Weight kg	Article No. galvanised	Article No. stainless steel
Trash box with plastic bucket, slotted grating, SW 75/9, trafficable, locked	500	160	419	4,3	40256	41209
Trash box with plastic bucket, mesh grating MW 30/10, trafficable, locked	500	160	419	4,9	40257	41219
Trash box with plastic bucket, mesh grating MW 30/10, galvanised, class B 125, locked	500	160	419	5,5	41229	-
Trash box with plastic bucket and GUGI-Ductile iron mesh grating MW 20/30, black, class C 250, locked	500	160	419	6,0	40259	-
Trash box with plastic bucket, ductile iron grating SW 80/14, black, class C 250, locked	500	160	419	6,2	40258	-
Trash box with plastic bucket and ductile iron grating, SW 6 mm, black, cl. C 250 locked	500	160	419	6,9	41239	-
Trash box with plastic-bucket, with perforated grating, stainless steel, car-traffic, locked	500	160	419	4,6	-	41249
Foul air trap, vertical, DN 100	-	-	-	0,5	40295	-
Foul air trap DN 100, inside	-	-	-	0,2	40290	-
End cap closed, made of PE-PP, for type 60	-	147	60	-	40284	-
End cap closed, made of PE-PP, for Type 80	-	147	80	-	40291	-
End cap combined made of PE-PP with outlet DN 70, type 01	-	160	135	0,1	40281	-
End cap combined made of PE-PP with outlet DN 70, type 010	-	160	185	0,2	40283	-
Drilling of connecting holes DN 100	-	-	-	-	972	-
Cutting to length of NW 100	-	-	-	-	990	-
Sealing material SikaBond TS Fast, 600 ml, tubular bag, black	-	-	-	0,6	6890	-
Tubular pistol for Sikaflex TS Fast	-	-	-	1,3	6891	-

The quality of the stainless steel material is according CNS 1.4301.

# RECYFIX® STANDARD 100

<b>LINEFIX®</b>	<b>RECYFIX® STREIF</b>	<b>RECYFIX® GREEN STANDARD</b>	<b>RECYFIX® GREEN SUPER</b>	<b>DACHFIX®</b>	<b>RECYFIX®POINT FASERFIX®POINT</b>	<b>FASERFIX® STANDARD</b>	<b>SLOTTED CHANNELS</b>	<b>RECYFIX® STANDARD</b>	<b>RECYFIX® PLUS</b>
-----------------	----------------------------	------------------------------------	---------------------------------	-----------------	---	-------------------------------	-----------------------------	------------------------------	--------------------------

# RECYFIX® STANDARD 150

## RECYFIX® STANDARD 150 - Combi article, car traffic

Type 01 with slotted grating,  
galvanised

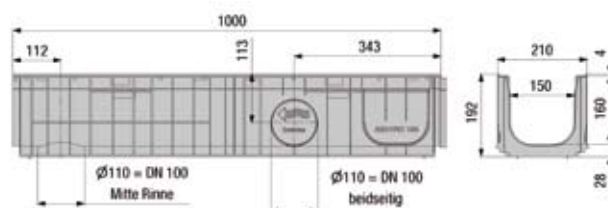
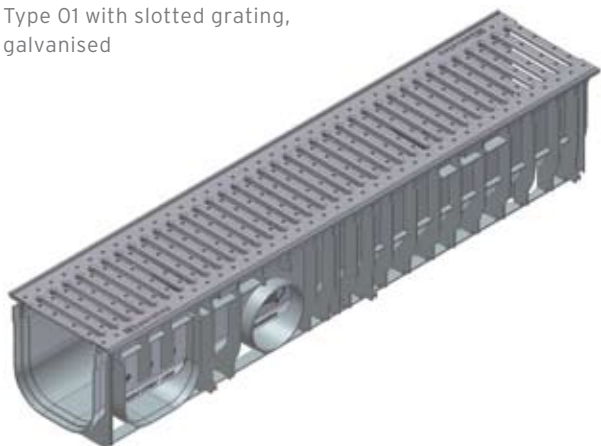

	Length mm	Width mm	Height mm	Drainage cross- sect. cm <sup>2</sup>	Intake cross- sect. cm <sup>2</sup> /m	Weight kg	Article No.
--	--------------	-------------	--------------	---	---	--------------	----------------

Type 01 with slotted grating, galvanised	1000	210	192	225	390	5,2	40163
--	------	-----	-----	-----	-----	-----	-------

## RECYFIX® STANDARD 150 - Combi article, class B 125

Type 01 with mesh grating  
MW 30/30, galvanised,  
locked

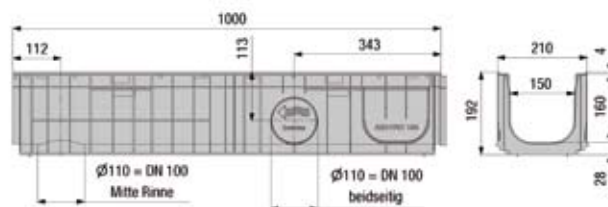
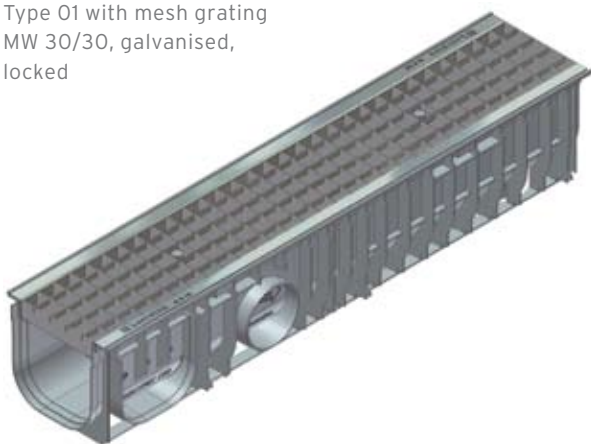

	Length mm	Width mm	Height mm	Drainage cross- sect. cm <sup>2</sup>	Intake cross- sect. cm <sup>2</sup> /m	Weight kg	Article No.
--	--------------	-------------	--------------	---	---	--------------	----------------

Type 01 with mesh grating MW 30/30, galvanised, locked	1000	210	192	225	1081	7,7	40171
Type 0105 with mesh grating MW 30/30, galvanised, locked	500	210	192	225	1081	3,8	40146
Type 01 with mesh grating MW 30/10, galvanised, locked	1000	210	192	225	1098	8,7	40177
Type 0105 with mesh grating MW 30/10, galvanised, locked	500	210	192	225	1098	4,5	40148

# RECYFIX® STANDARD 150

## RECYFIX® STANDARD 150 - Combi article, class C 250

Tyyp 01 with GUGI-Ductile iron mesh grating MW 20/30, black, locked

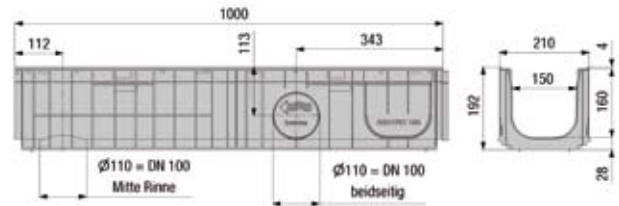
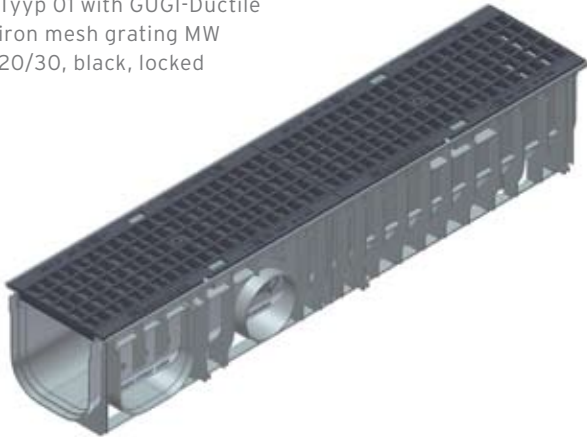

	Length mm	Width mm	Height mm	Drainage cross- sect. cm <sup>2</sup>	Intake cross- sect. cm <sup>2</sup> /m	Weight kg	Article No.
Tyyp 01 with GUGI-Ductile iron mesh grating MW 20/30, black, locked	1000	210	192	225	745	11,9	40174
Type 0105 with GUGI-Ductile iron mesh grating MW 20/30, black, locked	500	210	192	225	745	6,0	40149

RECYFIX® PLUS

RECYFIX® STANDARD

SLOTTED CAHNNELS

FASERFIX® STANDARD

RECYFIX® POINT  
FASERFIX® POINT

DACHFIX®

RECYFIX® GREEN SUPER

RECYFIX® GREEN STANDARD

RECYFIX® STREIF

LINEFIX®

# RECYFIX® STANDARD 150

## RECYFIX® STANDARD 150 - Accessories

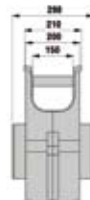
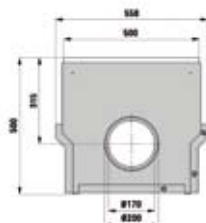

Trash box with galvanised bucket, with mesh grating MW 30/10, galvanised, class B 125, locked



Foul air trap, vertical, DN 100

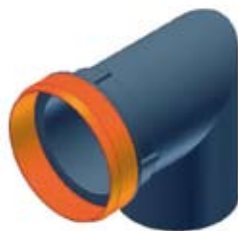

Foul air trap DN 100, inside

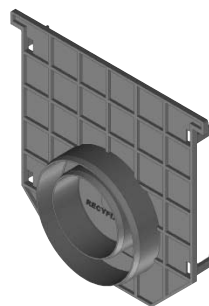

End cap combined made of PE-PP with outlet DN 70/100, Type 01

	Length mm	Width mm	Height mm	Weight kg	Article No.
Trash box with galvanised bucket, with mesh grating MW 30/30, galvanised, class B125, locked	500	210	495	19,9	40154
Trash box with galvanised bucket, with mesh grating MW 30/10, galvanised, class B 125, locked	500	210	495	17,8	40156
Trash box with galvanise bucket with GUGI-Ductile iron mesh grating MW 20/30, black, class C 250, locked	500	210	495	19,6	40153
Foul air trap, vertical, DN 100	-	-	-	0,5	40295
Foul air trap DN 100, inside	-	-	-	0,2	40290
End cap combined made of PE-PP with outlet DN 70/100, Type 01	-	210	202	0,1	40191
Drilling of connecting holes DN 150	-	-	-	-	973
Cutting to length of NW 150	-	-	-	-	991
Sealing material SikaBond TS Fast, 600 ml, tubular bag, black	-	-	-	0,6	6890
Tubular pistol for Sikaflex TS Fast	-	-	-	1,3	6891

<b>LINEFIX®</b>	<b>RECYFIX® STREIF</b>	<b>RECYFIX® GREEN STANDARD</b>	<b>RECYFIX® GREEN SUPER</b>	<b>DACHFIX®</b>	<b>RECYFIX®POINT FASERFIX®POINT</b>	<b>FASERFIX® STANDARD</b>	<b>SLOTTED CAHNNELS</b>	<b>RECYFIX® STANDARD</b>	<b>RECYFIX® PLUS</b>
-----------------	----------------------------	------------------------------------	---------------------------------	-----------------	---	-------------------------------	-----------------------------	------------------------------	--------------------------



# RECYFIX®STANDARD 200

## RECYFIX®STANDARD 200 - Combi article, class B 125

Type 010 with mesh grating  
MW 30/30, galvanised,  
locked

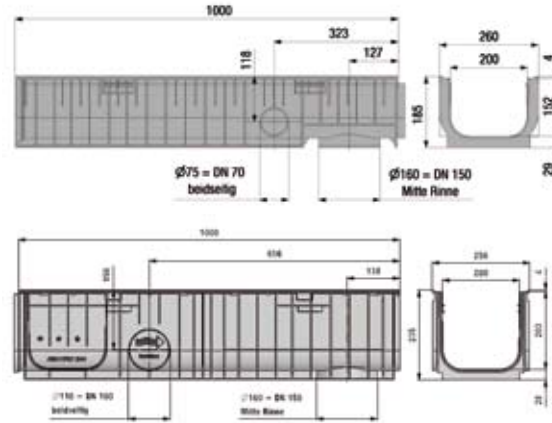
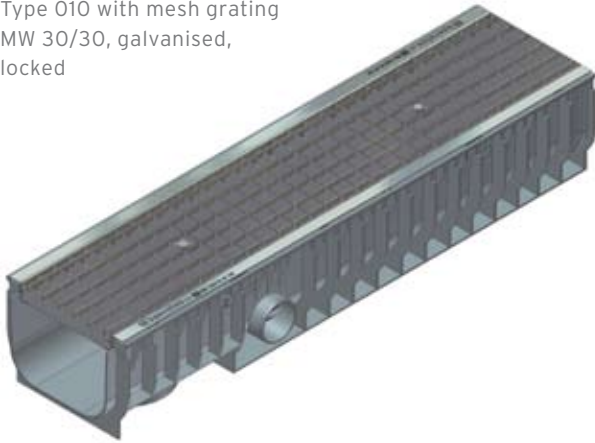

	Length mm	Width mm	Height mm	Drainage cross- sect. cm <sup>2</sup>	Intake cross- sect. cm <sup>2</sup> /m	Weight kg	Article No.
--	--------------	-------------	--------------	---	---	--------------	----------------

Type 010 with mesh grating MW 30/30, galvanised, locked	1000	256	185	290	1620	9,3	40672
Type 020 with mesh grating MW 30/30, galvanised, locking device	1000	256	235	366	1620	10,2	40676
Type 010 with mesh grating MW 30/10, galvanised, locked	1000	256	185	290	1442	11,2	40685
Type 020 with mesh grating MW 30/10, galvanised, with locking device	1000	256	235	366	1442	11,3	40686

## RECYFIX®STANDARD 200 - Combi article, class C 250

Type 010 with ductile iron  
grating 2 x 85/20, black,  
locked

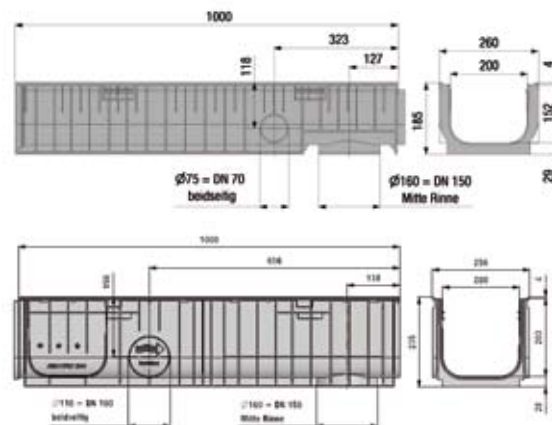

	Length mm	Width mm	Height mm	Drainage cross- sect. cm <sup>2</sup>	Intake cross- sect. cm <sup>2</sup> /m	Weight kg	Article No.
--	--------------	-------------	--------------	---	---	--------------	----------------

Type 010 with GUGI-Ductile iron mesh grating MW 20/30, black, locked	1000	256	185	290	825	15,4	40665
Type 020 with GUGI-Ductile iron mesh grating MW 20/30, black, locked	1000	256	235	366	825	15,8	40666
Type 010 with ductile iron grating 2 x 85/20, black, locked	1000	256	185	290	822	15,0	40660
Type 020 with ductile iron grating 2 x 85/20, black, locked	1000	256	235	366	822	15,4	40661

# RECYFIX®STANDARD 200

## RECYFIX®STANDARD 200 - Accessories



Trash box with mesh grating MW 30/10, galvanised, cl. B 125, locked

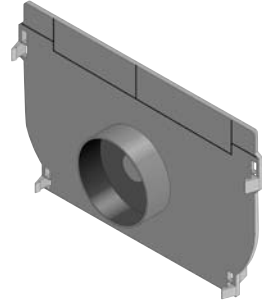
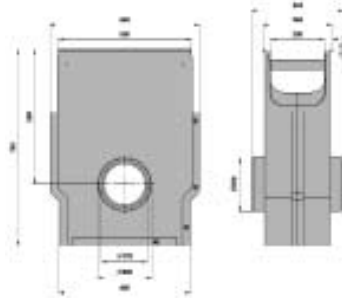

End cap combined made of PE-PP with outlet DN 70, Type 010

	Length mm	Width mm	Height mm	Weight kg	Article No.
Trash box with mesh grating MW 30/30, galvanised, cl. B 125, locked	500	256	734	27,0	40656
Trash box with mesh grating MW 30/10, galvanised, cl. B 125, locked	500	256	734	28,6	40657
Trash box with GUGI-Ductile iron mesh grating MW 20/30, black, cl. C 250, locked	500	256	734	30,8	40653
Trash box with ductile iron grating 2 x 85/20, black, class C 250, locked	500	256	734	30,6	40654
End cap combined made of PE-PP with outlet DN 70, Type 010	-	258	185	0,2	40692
End cap closed, Type 01	-	260	275	0,9	12081
Drilling of connecting holes DN 200	-	-	-	-	974
Cutting to length of NW 200	-	-	-	-	992
Sealing material SikaBond TS Fast, 600 ml, tubular bag, black	-	-	-	0,6	6890
Tubular pistol for Sikaflex TS Fast	-	-	-	1,3	6891

RECYFIX®  
PLUS

RECYFIX®  
STANDARD

SLOTTED  
CHANNELS

FASERFIX®  
STANDARD

RECYFIX®POINT  
FASERFIX®POINT

DACHFIX®

RECYFIX®  
GREEN SUPER

RECYFIX®  
GREEN STANDARD

RECYFIX®  
STREIF

LINEFIX®

# RECYFIX®STANDARD 300

## RECYFIX®STANDARD 300 - Combi article, class C 250

Type 010 with GUGI-Ductile iron mesh grating, MW 20/30, black, locked

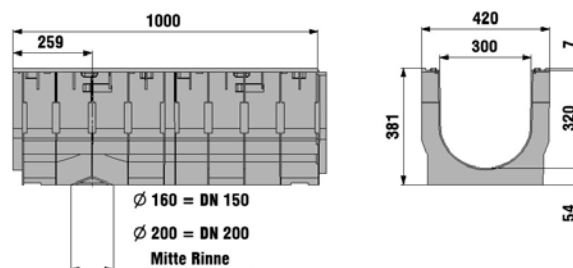
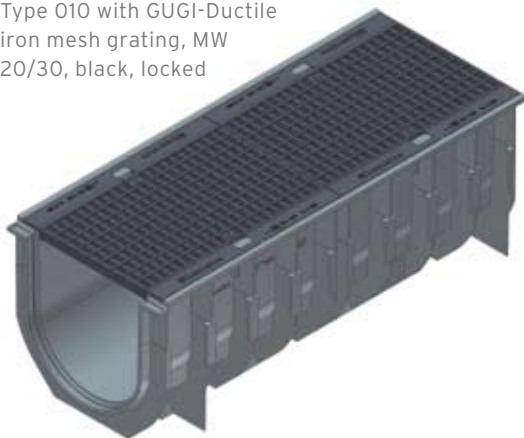

Length mm	Width mm	Height mm	Drainage cross- sect. cm <sup>2</sup>	Intake cross- sect. cm <sup>2</sup> /m	Weight kg	Article No.
--------------	-------------	--------------	---	---	--------------	----------------

Type 010 with GUGI-Ductile iron mesh grating, MW 20/30, black, locked

1000	420	380	857	1385	33,2	40875
------	-----	-----	-----	------	------	-------

## RECYFIX®STANDARD 300 - Accessories



End cap closed, galvanised, Type 010



End cap with horizontal UPVC-outlet DN 200, galvanised, Type 010

	Length mm	Width mm	Height mm	Weight kg	Article No.
End cap closed, galvanised, Type 010	-	420	380	2,8	40881
End cap with horizontal UPVC-outlet DN 200, galvanised, Type 010	-	420	380	3,2	40891
Drilling of connecting holes DN 200	-	-	-	-	974
Cutting to length of NW 300	-	-	-	-	993
Sealing material SikaBond TS Fast, 600 ml, tubular bag, black	-	-	-	0,6	6890
Tubular pistol for Sikaflex TS Fast	-	-	-	1,3	6891