

# RECYFIX® PLUS

**STABLE DRAINAGE.**

WITH EDGE PROTECTION AND ATTRACTIVE DESIGN.



## AT A GLANCE

- ✓ For commercial precincts up to load class C 250 in accordance with DIN EN 1433
- ✓ Additional strength through galvanized / stainless steel frame
- ✓ Attractive appearance through visible metal edge



# RECYFIX® PLUS

## STABLE DRAINAGE.

WITH EDGE PROTECTION AND ATTRACTIVE DESIGN.

### THE ECOLOGICAL INNOVATION

RECYFIX PLUS channels consist of 100 % pure recycled polyolefine plastics. They can be integrated into the ecological material cycle and are 100 % recyclable. Green light for the environment! Because of their low weight, RECYFIX PLUS channels are easy to transport and install. At the same time, the system complies with the highest requirements regarding functionality and strength. RECYFIX PLUS channels have been developed for traffic areas exposed to high loads. An additional protection is provided by galvanised steel angle housings covering the top edges. The RECYFIX PLUS channel system is a complete system with all necessary accessories.



Installation in polygonal patterns

### HIGH-TECH DEVELOPMENT

RECYFIX PLUS channels have been developed in co-operation with a well-known research institute for plastic recycling. With the help of computer simulation it was possible to create a highly rigid construction with torsion-free ribs, which weighs significantly less than conventional channels made of mineral-based materials but has good performance characteristics and durability.

### RECYCLED PE-PP MATERIAL

RECYFIX PLUS channels consist of 100 % pure recycled polyolefine plastics. The material is characterised by its high chemical resistance, resistance to frost and salt, it is UV-stabilised, environmentally neutral and leakproof.

### DIN EN 1433

All RECYFIX PLUS channels meet the requirements of the European standard DIN EN 1433. The products carry the CE-mark.



Parking area

## A COMPREHENSIVE SYSTEM

RECYFIX PLUS channels are available in different heights and nominal widths. Canal connections are possible at the bottom, on the sides or ends. A choice of channel gratings is available to suit different surface finishes and load applications. The system is rounded off with end caps, foul air locks for vertical outlet and trash boxes with plastic mud bucket - optionally with internal foul air trap.



RECYFIX®  
PLUS

RECYFIX®  
STANDARD

SLOTTED  
CHANNELS

FASERFIX®  
STANDARD

RECYFIX®POINT  
FASERFIX®POINT

DACHFIX®

RECYFIX®  
GREEN SUPER

RECYFIX®  
GREEN STANDARD

RECYFIX®  
STREIF

LINEFIX®

# RECYFIX® PLUS

## STABLE DRAINAGE.

WITH EDGE PROTECTION AND ATTRACTIVE DESIGN.

RECYFIX® PLUS channels meet the requirements of DIN EN 1433 and are suitable for the following loading capacities:



**CATEGORY A 15,  
LOAD CLASS 15 KN**



**CATEGORY B 125,  
LOAD CLASS 125 KN**



**CATEGORY C 250,  
LOAD CLASS 250 KN**

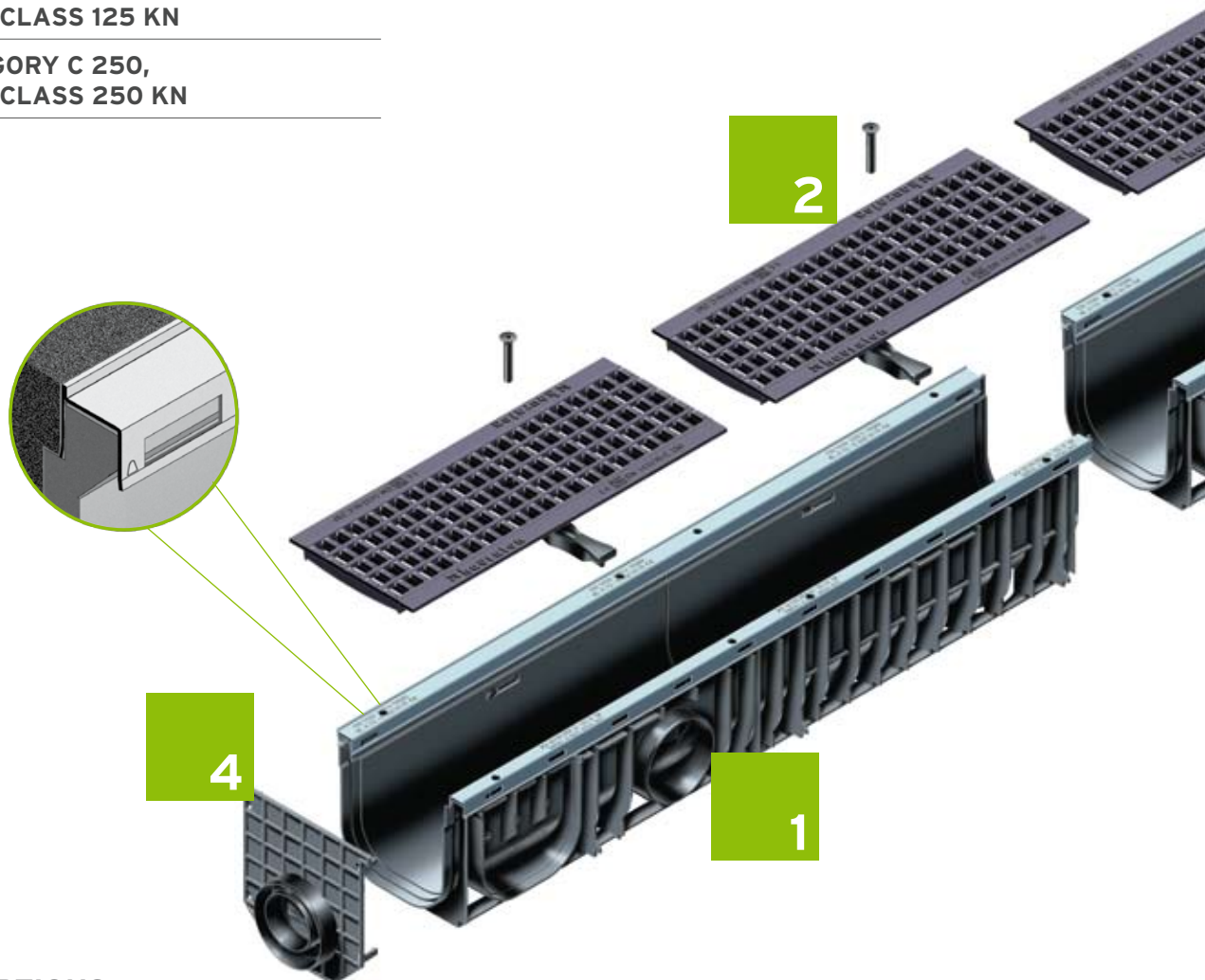

### GRATING OPTIONS FOR RECYFIX PLUS CHANNELS

GUGI-Ductile iron mesh gratings\*



Ductile iron gratings\*



Slotted gratings\*



Steel gratings\*

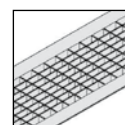

**Loading capacities as per DIN EN 1433 suitable for passenger car traffic**

**B 125**

100

100

100, 150, 200

**C 250**

100, 150, 200, 300

100, 200

\* nominal width

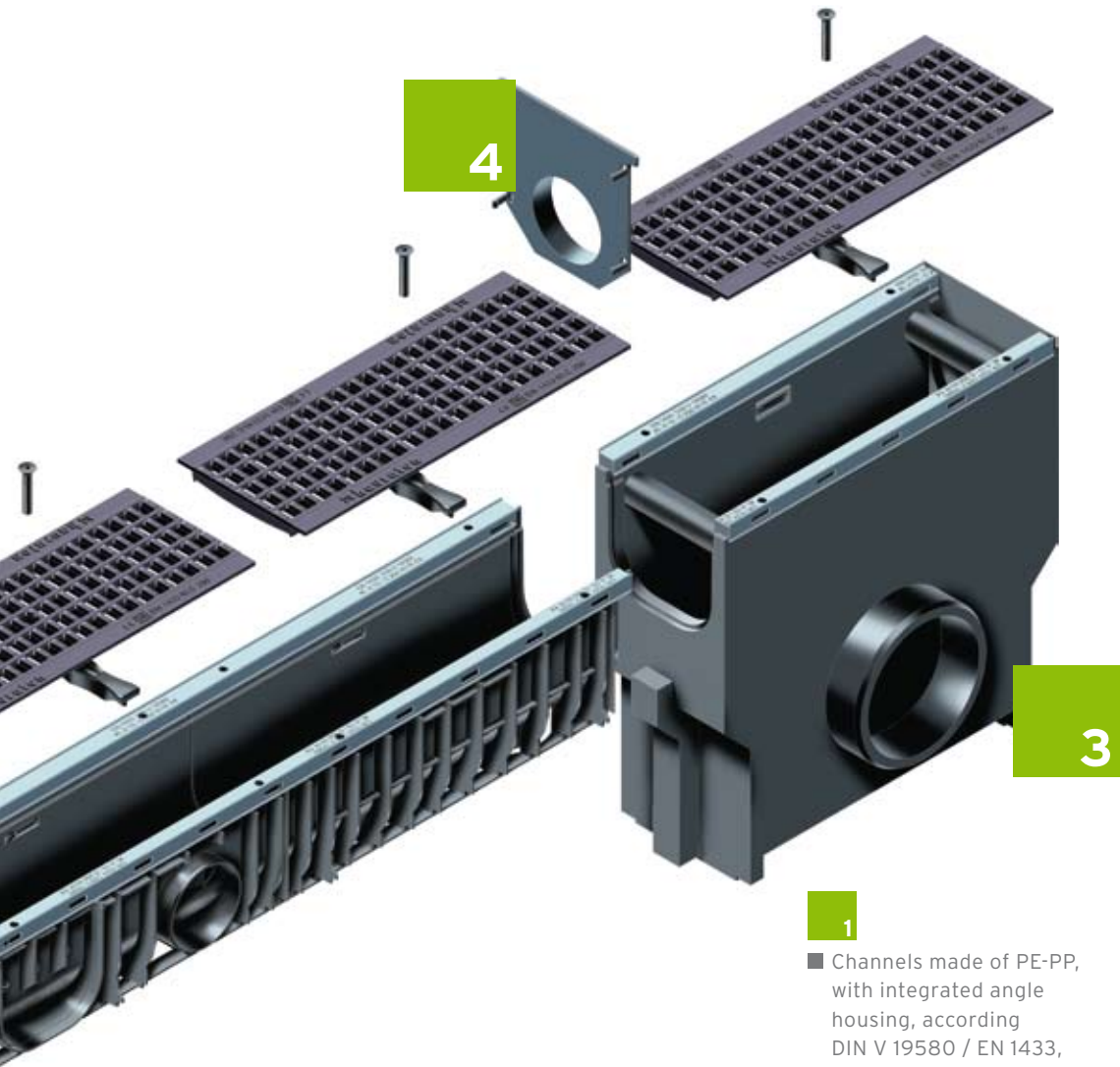

**1**

■ Channels made of PE-PP, with integrated angle housing, according DIN V 19580 / EN 1433, CE-conform, with tongue and groove connection for exact installation

**2**

■ numerous grating options, for exemple GUGI-Ductile iron mesh gratings

**3**

■ Trash box with pipe-connection possibilities

**4**

■ End caps with and without outlets

### SAFETY IN PEDESTRIAN ZONES

RECYFIX PLUS channels with their great choice of gratings are also used in pedestrian zones, on market squares and other public areas. To provide greater safety for pedestrians, gratings with narrow mesh sizes have been developed.



RECYFIX® PLUS

RECYFIX® STANDARD

SLOTTED CHANNELS

FASERFIX® STANDARD

RECYFIX® POINT  
FASERFIX® POINT

DACHFIX®

RECYFIX® GREEN SUPER

RECYFIX® GREEN STANDARD

RECYFIX® STREIF

LINEFIX®

# RECYFIX® PLUS 100

## RECYFIX® PLUS 100 - Combi article, class A 15

Type 60 with perforated grating, stainless steel, locked\*

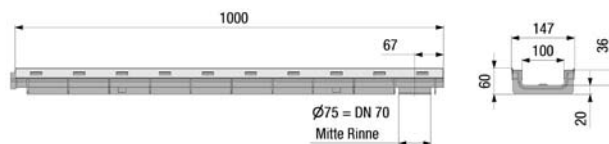
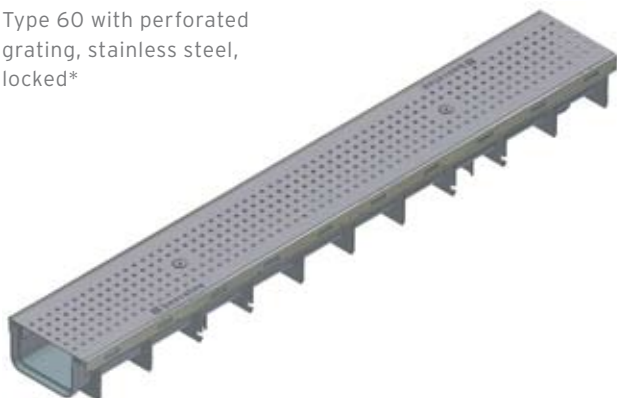

Type 01 with perforated grating, stainless steel, locked

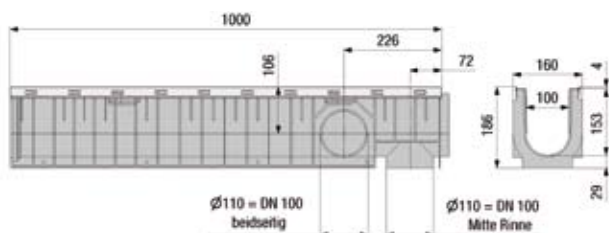
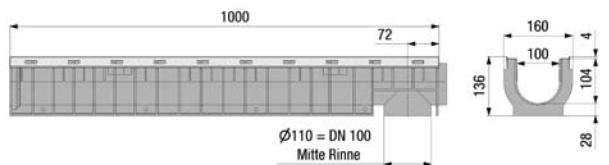
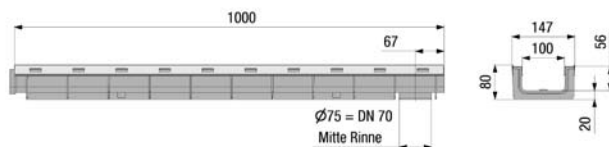
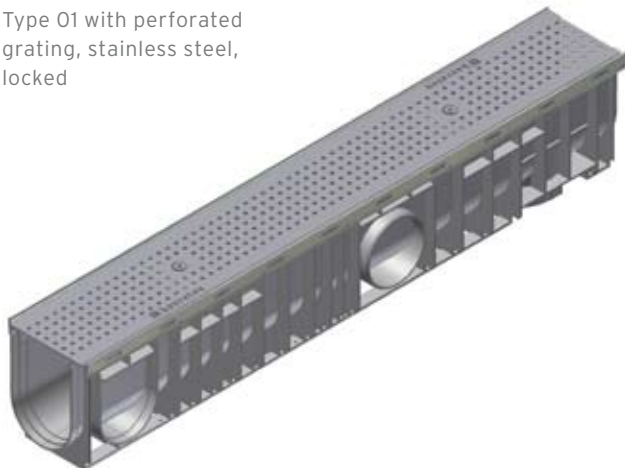

	Length mm	Width mm	Height mm	Drainage cross- sect. cm <sup>2</sup>	Intake cross- sect. cm <sup>2</sup> /m	Weight kg	Article No. galvanised	Article No. stainless steel
Type 60 with perforated grating, stainless steel, locked*	1000	147	60	25	161	3,9	-	41444
Type 80 with perforated grating, stainless steel, locked*	1000	147	80	45	161	4,1	-	41446
Type 01 with perforated grating, stainless steel, locked	1000	160	135	92	161	5,5	-	41440
Type 010 with perforated grating, stainless steel, locked	1000	160	185	142	161	6,4	-	41442
Type 0105 with perforated grating, stainless steel, locked	500	160	135	92	161	2,8	-	41447
Type 01005 with perforated grating, stainless steel, locked	500	160	185	142	161	3,2	-	41448

# RECYFIX® PLUS 100

## RECYFIX® PLUS 100 - Combi article, car traffic

Type 60 with slotted grating SW 75/9, locked\*

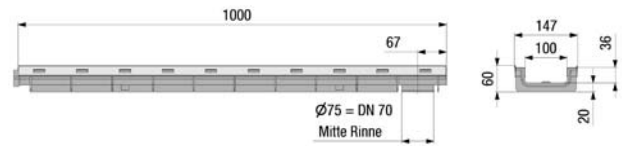

Type 010 with mesh grating MW 30/10, locked

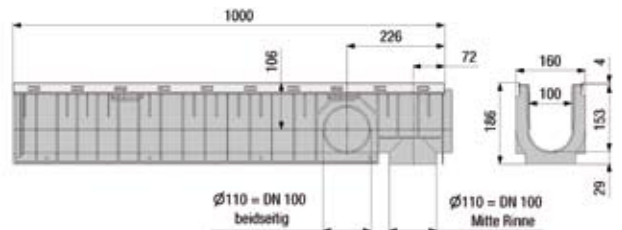
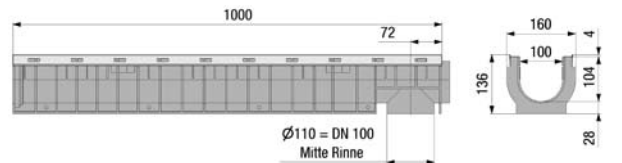
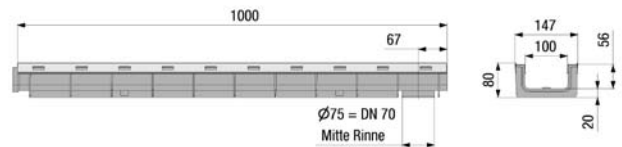
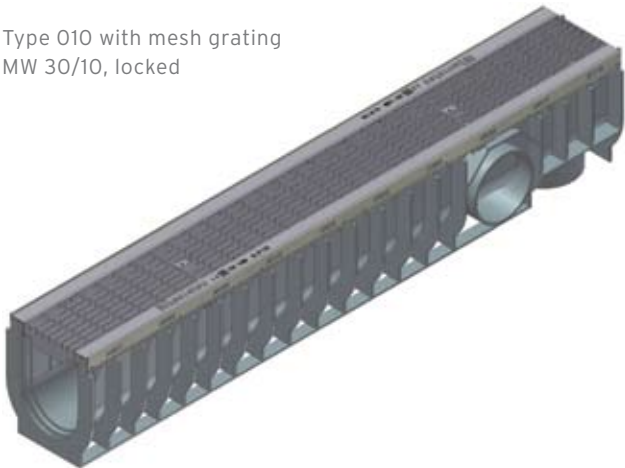

	Length mm	Width mm	Height mm	Drainage cross- sect. cm <sup>2</sup>	Intake cross- sect. cm <sup>2</sup> /m	Weight kg	Article No. galvanised	Article No. stainless steel
Type 60 with slotted grating SW 75/9, locked*	1000	147	60	25	280	4,0	40332	41404
Type 80 with slotted grating SW 75/9, locked*	1000	147	80	45	280	4,1	40337	41406
Type 60 with mesh grating MW 30/10, locked*	1000	147	60	25	650	5,2	40333	41414
Type 80 with mesh grating MW 30/10, locked*	1000	147	80	45	650	5,3	40338	41416
Type 01 with slotted grating SW 75/9, locked	1000	160	135	92	280	5,3	40344	41400
Type 0105 with slotted grating SW 75/9, locked	500	160	135	92	280	2,8	40347	41407
Type 010 with slotted grating SW 75/9, locked	1000	160	185	142	280	6,3	40339	41402
Type 01005 with slotted grating SW 75/9, locked	500	160	185	142	280	3,2	40341	41408
Type 01 with mesh grating MW 30/10, locked	1000	160	135	92	650	6,5	40346	41410
Type 0105 with mesh grating MW 30/10, locked	500	160	135	92	650	3,4	40348	41417
Type 010 with mesh grating MW 30/10, locked	1000	160	185	142	650	7,5	40340	41412
Type 01005 with mesh grating MW 30/10, locked	500	160	185	142	650	3,8	40343	41418

The quality of the stainless steel material is according CNS 1.4301.

RECYFIX® PLUS

RECYFIX® STANDARD

SLOTTED CHANNELS

FASERFIX® STANDARD

RECYFIX® POINT  
FASERFIX® POINT

DACHFIX®

RECYFIX® GREEN SUPER

RECYFIX® GREEN STANDARD

RECYFIX® STREIF

LINEFIX®



# RECYFIX® PLUS 100

## RECYFIX® PLUS 100 - Combi article, class B 125

Type 80 with mesh grating  
MW 30/10, galvanised,  
locked\*

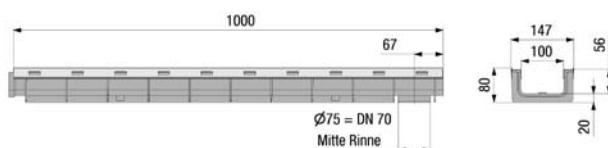
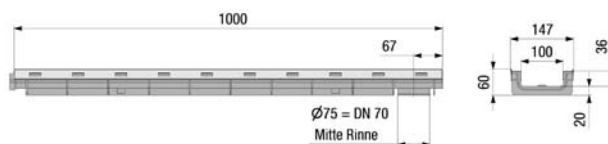
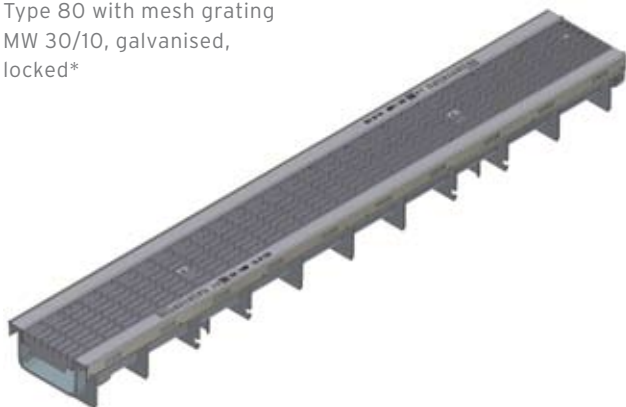

Type 010 with mesh grating  
MW 30/10, galvanised,  
locked

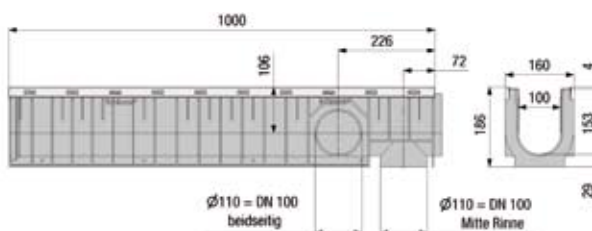
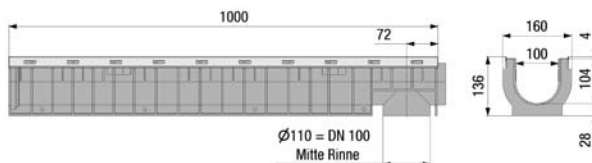
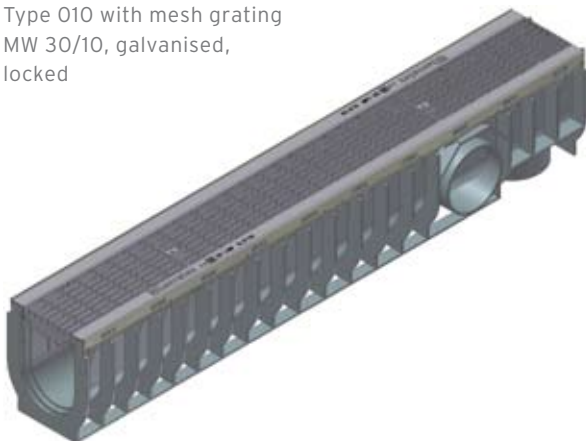

	Length mm	Width mm	Height mm	Drainage cross- sect. cm <sup>2</sup>	Intake cross- sect. cm <sup>2</sup> /m	Weight kg	Article No.
Type 60 with mesh grating MW 30/10, galvanised, locked*	1000	147	60	25	650	6,0	41424
Type 80 with mesh grating MW 30/10, galvanised, locked*	1000	147	80	45	650	6,2	41426
Type 01 with mesh grating MW 30/10, galvanised, locked	1000	160	135	92	650	7,5	41420
Type 0105 with mesh grating MW 30/10, galvanised, locked	500	160	135	92	650	4,0	41427
Type 010 with mesh grating MW 30/10, galvanised, locked	1000	160	185	142	650	8,5	41422
Type 01005 with mesh grating MW 30/10, galvanised, locked	500	160	185	142	650	4,4	41428

\* For common frequented areas we recommend FASERFIX SUPER KS channels, flat (catalogue CIVILS).

# RECYFIX® PLUS 100

## RECYFIX® PLUS 100 - Combi article, class C 250

Type 60 with GUGI-Ductile iron mesh grating MW 20/30, black, locked\*



Type 01 with GUGI-Ductile iron mesh grating MW 20/30, black, locked

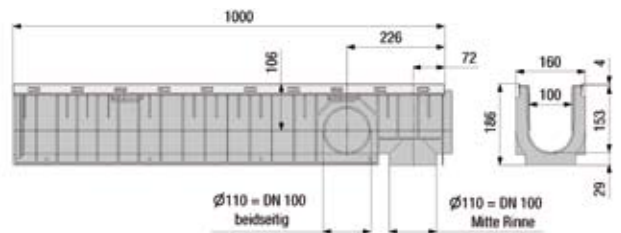
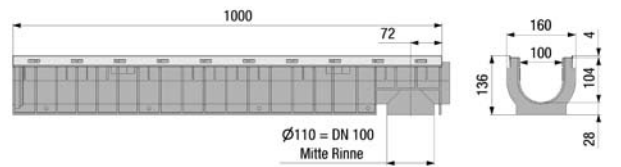
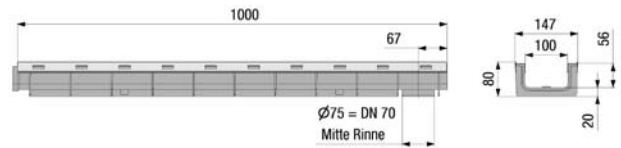
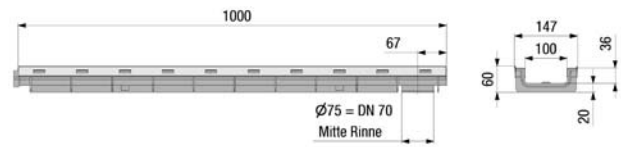
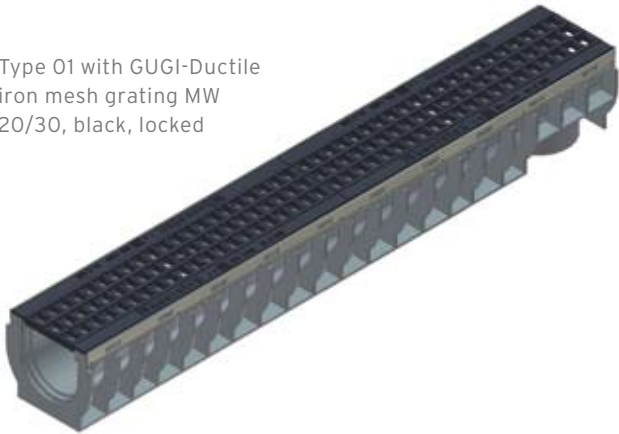

	Length mm	Width mm	Height mm	Drainage cross- sect. cm <sup>2</sup>	Intake cross- sect. cm <sup>2</sup> /m	Weight kg	Article No.
Type 60 with GUGI-Ductile iron mesh grating MW 20/30, black, locked*	1000	147	60	25	444	7,4	40359
Type 80 with GUGI-Ductile iron mesh grating MW 20/30, black, locked*	1000	147	80	45	444	7,4	40364
Type 60 with ductile iron grating SW 80/14, black, locked*	1000	147	60	25	450	7,8	40362
Type 60 with ductile iron grating SW 80/6, black, locked*	1000	147	60	25	290	8,6	40372
Type 80 with ductile iron grating SW 80/14, black, locked*	1000	147	80	45	450	8,0	40367
Type 80 with ductile iron grating SW 80/6, black, locked*	1000	147	80	45	290	8,8	40377
Type 01 with GUGI-Ductile iron mesh grating MW 20/30, black, locked	1000	160	135	92	444	8,6	40360
Type 0105 with GUGI-Ductile iron mesh grating MW 20/30, black, locked	500	160	135	92	444	7,4	40365
Type 010 with GUGI-Ductile iron mesh grating MW 20/30, black, locked	1000	160	185	142	444	9,5	40380
Type 0105 with GUGI-Ductile iron mesh grating MW 20/30, black, locked	500	160	185	142	444	7,8	40385
Type 01 with ductile iron grating SW 80/14, locked	1000	160	135	92	450	9,0	40361
Type 01 with ductile iron grating SW 80/6, locked	1000	160	135	92	290	10,0	40363
Type 0105 with ductile iron grating SW 80/14, locked	500	160	135	92	450	7,6	40366
Type 0105 with ductile iron grating SW 80/6, locked	500	160	135	92	290	8,1	40368
Type 010 with ductile iron grating SW 80/14, locked	1000	160	185	142	450	9,9	40381
Type 010 with ductile iron grating SW 80/6, locked	1000	160	185	142	290	10,9	40383
Type 0105 with ductile iron grating SW 80/14, locked	500	160	185	142	450	8,0	40386
Type 0105 with ductile iron grating SW 80/6, locked	500	160	185	142	290	8,5	40388

\* For common frequented areas we recommend FASERFIX SUPER KS channels, flat (catalogue CIVILS).

# RECYFIX® PLUS 100

## RECYFIX® PLUS 100 - Accessories



Trash box with plastic bucket, with GUGI-Ductile iron mesh grating MW 20/30, black, class C 250, locked



Trash box with plastic bucket, with ductile iron grating SW 80/14, black, class C 250, locked

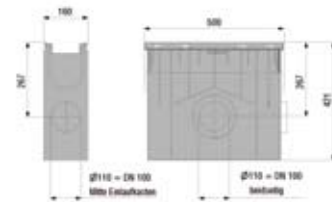

Foul air trap, vertical, DN 100



Foul air trap DN 100, inside



End cap combined made of PE-PP with outlet DN 70, type 01

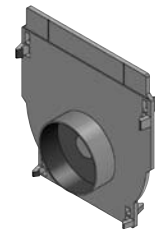

End cap combined made of PE-PP with outlet DN 70, type 010

	Length mm	Width mm	Height mm	Weight kg	Article No. galvanised	Article No. stainless steel
Trash box with plastic bucket, with slotted grating SW 75/6, trafficable, locked	500	160	419	4,8	40353	41409
Trash box with plastic backed, with slotted grating SW 75/6, trafficable, locked	500	160	419	5,4	40354	41419
Trash box with plastic-bucket, with mesh grating MW 30/10, class B 125, locked	500	160	419	6,2	41429	-
Trash box with plastic bucket, with GUGI-Ductile iron mesh grating MW 20/30, black, class C 250, locked	500	160	419	6,6	40358	-
Trash box with plastic bucket, with ductile iron grating SW 80/14, black, class C 250, locked	500	160	419	6,8	40356	-
Trash box with plastic bucket, with ductile iron grating SW 80/6, black, class C 250, locked	500	160	419	7,3	40357	-
Trash box with plastic-bucket, with perforated grating, stainless steel, car-traffic, locked	500	160	419	5,1	-	41449
Foul air trap, vertical, DN 100	-	-	-	0,5	40295	-
Foul air trap DN 100, inside	-	-	-	0,2	40290	-
End cap closed, made of PE-PP, for type 60	-	147	60	-	40284	-
End cap closed, made of PE-PP, for Type 80	-	147	80	-	40291	-
End cap combined made of PE-PP with outlet DN 70, type 01	-	160	135	0,1	40281	-
End cap combined made of PE-PP with outlet DN 70, type 010	-	160	185	0,2	40283	-
Drilling of connecting holes DN 100	-	-	-	-	972	-
Cutting to length of NW 100	-	-	-	-	990	-
Sealing material SikaBond TS Fast, 600 ml, tubular bag, black	-	-	-	0,6	6890	-
Tubular pistol for Sikaflex TS Fast	-	-	-	1,3	6891	-

The quality of the stainless steel material is according CNS 1.4301.

# RECYFIX® PLUS 100

RECYFIX®  
PLUS

RECYFIX®  
STANDARD

SLOTTED  
CHANNELS

FASERFIX®  
STANDARD

RECYFIX®POINT  
FASERFIX®POINT

DACHFIX®

RECYFIX®  
GREEN SUPER

RECYFIX®  
GREEN STANDARD

RECYFIX®  
STREIF

LINEFIX®

# RECYFIX® PLUS 150

## RECYFIX® PLUS 150 - Combi article, class B 125

Type 01 with mesh grating  
MW 30/30, galvanised,  
locked

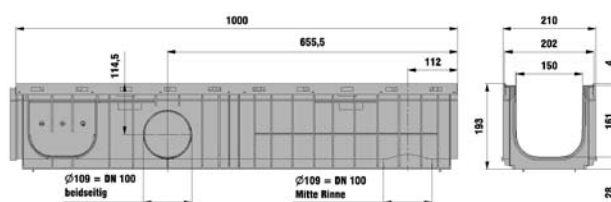
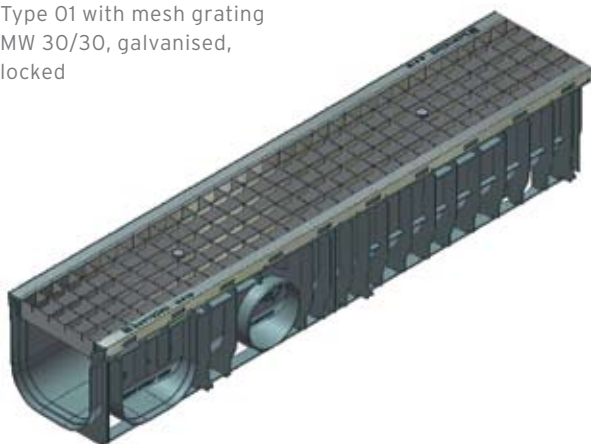

	Length mm	Width mm	Height mm	Drainage cross- sect. cm <sup>2</sup>	Intake cross- sect. cm <sup>2</sup> /m	Weight kg	Article No.
--	--------------	-------------	--------------	---------------------------------------------	-------------------------------------------------	--------------	----------------

Type 01 with mesh grating MW 30/30, galvanised, locked	1000	210	192	225	1081	7,8	41071
Type 0105 with mesh grating MW 30/30, galvanised, locked	500	210	192	225	1081	3,9	41046
Type 01 with mesh grating MW 30/10, galvanised, locked	1000	210	192	225	1098	8,8	41077
Type 0105 with mesh grating MW 30/10, galvanised, locked	500	210	192	225	1098	2,9	41048

## RECYFIX® PLUS 150 - Combi article, class C 250

Type 01 with GUGI-Ductile  
iron mesh grating, black,  
locked

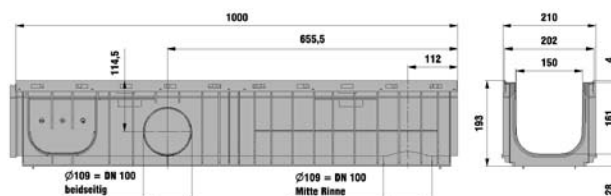
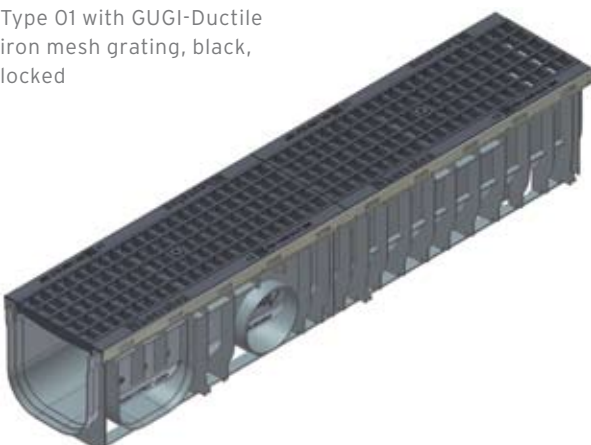

	Length mm	Width mm	Height mm	Drainage cross- sect. cm <sup>2</sup>	Intake cross- sect. cm <sup>2</sup> /m	Weight kg	Article No.
--	--------------	-------------	--------------	---------------------------------------------	-------------------------------------------------	--------------	----------------

Type 01 with GUGI-Ductile iron mesh grating, black, locked	1000	210	192	225	745	13,8	41075
Type 0105 with GUGI-Ductile iron mesh grating MW 20/30, black, locked	500	210	192	225	745	6,1	41049

# RECYFIX® PLUS 150

## RECYFIX® PLUS 150 - Accessories

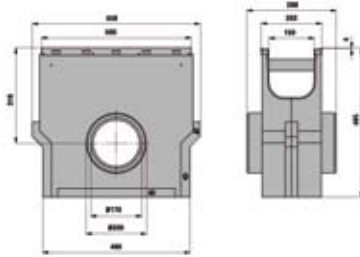

Trash box with galvanised bucket, with mesh grating MW 30/10, galvanised, class B 125, locked



Foul air trap, vertical, DN 100

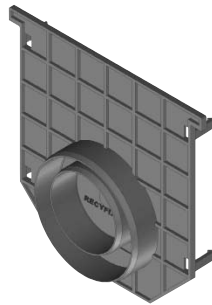

End cap combined made of PE-PP with outlet DN 70/100, Type 01

	Length mm	Width mm	Height mm	Weight kg	Article No.
Trash box with galvanised bucket, with mesh grating MW 30/30, galvanised, class B 125, locked	500	202	496	18,6	41054
Trash box with galvanised bucket, with mesh grating MW 30/10, galvanised, class B 125, locked	500	202	496	18,6	41056
Trash box with galvanised bucket, with GUGI-Ductile iron mesh grating MW 20/30, galvanised, class C250 locked	500	202	496	20,7	41053
Foul air trap, vertical, DN 100	-	-	-	0,5	40295
End cap combined made of PE-PP with outlet DN 70/100, Type 01	-	210	202	0,1	40191
Drilling of connecting holes DN 150	-	-	-	-	973
Cutting to length of NW 150	-	-	-	-	991
Sealing material SikaBond TS Fast, 600 ml, tubular bag, black	-	-	-	0,6	6890
Tubular pistol for Sikaflex TS Fast	-	-	-	1,3	6891

RECYFIX® PLUS

RECYFIX® STANDARD

SLOTTED CHANNELS

FASERFIX® STANDARD

RECYFIX® POINT  
FASERFIX® POINT

DACHFIX®

RECYFIX® GREEN SUPER

RECYFIX® GREEN STANDARD

RECYFIX® STREIF

LINEFIX®

# RECYFIX® PLUS 200

## RECYFIX® PLUS 200 - Combi article, class B 125

Type 010 with mesh grating  
MW 30/30, galvanised,  
locked

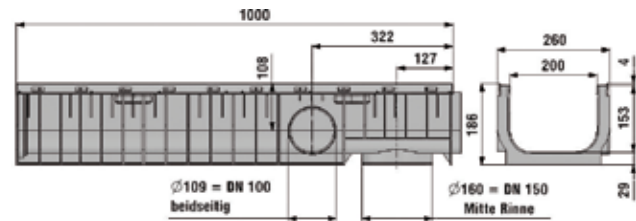
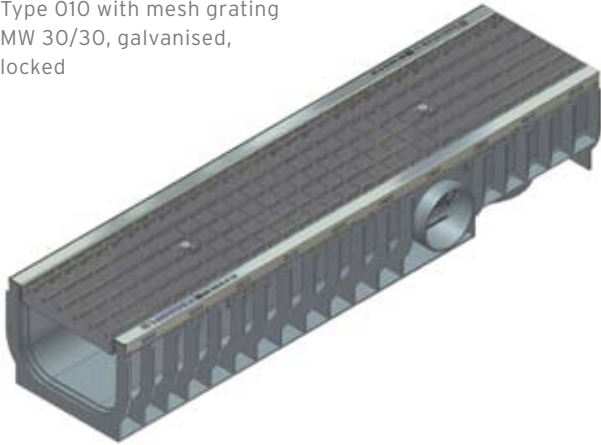

Type 020 with mesh grating  
MW 30/10, galvanised,  
locked

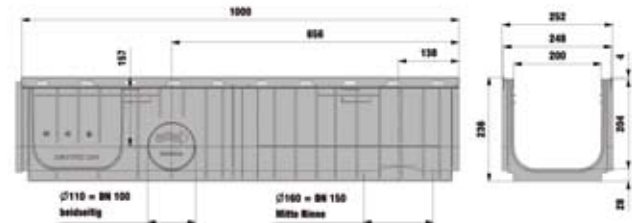

	Length mm	Width mm	Height mm	Drainage cross- sect. cm <sup>2</sup>	Intake cross- sect. cm <sup>2</sup> /m	Weight kg	Article No.
Type 010 with mesh grating MW 30/30, galvanised, locked	1000	258	186	290	1620	10,3	40771
Type 020 with mesh grating MW 30/30, galvanised, locked	1000	252	236	366	1620	11,5	40773
Type 010 with mesh grating MW 30/10, galvanised, locked	1000	258	186	290	1442	12,2	40785
Type 020 with mesh grating MW 30/10, galvanised, locked	1000	252	236	366	1442	12,7	40786

# RECYFIX® PLUS 200

## RECYFIX® PLUS 200 - Combi article, class C 250

Type 010 with GUGI-Ductile iron mesh grating MW 20/30, black, locked

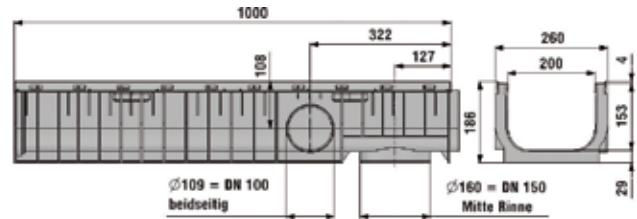
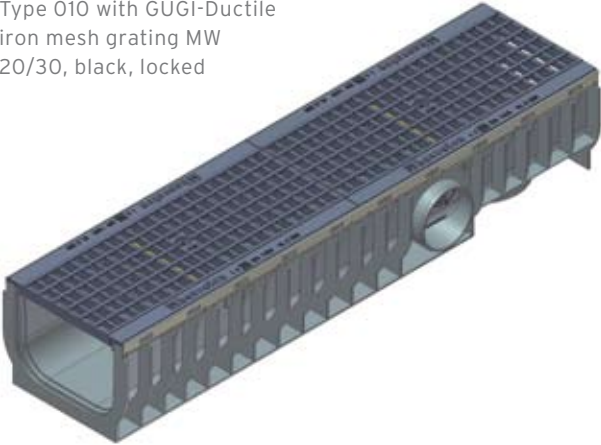

Type 020 with GUGI-Ductile iron mesh grating MW 20/30, black, locked

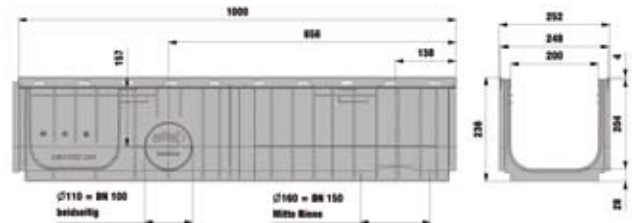
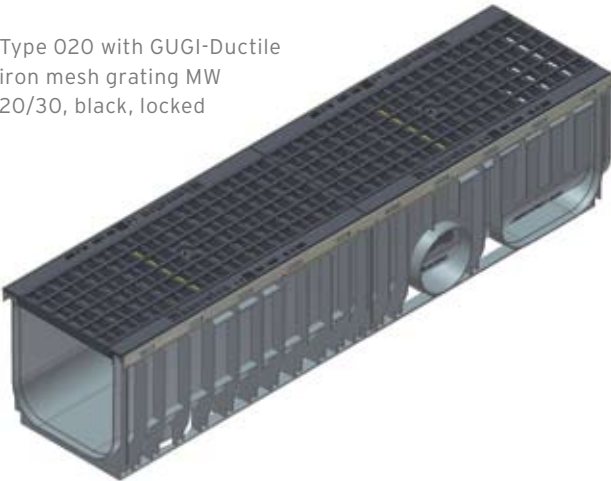

	Length mm	Width mm	Height mm	Drainage cross- sect. cm <sup>2</sup>	Intake cross- sect. cm <sup>2</sup> /m	Weight kg	Article No.
Type 010 with GUGI-Ductile iron mesh grating MW 20/30, black, locked	1000	258	186	290	825	16,6	40770
Type 020 with GUGI-Ductile iron mesh grating MW 20/30, black, locked	1000	252	236	366	825	17,2	40774
Type 010 with Ductile iron grating 2 x 85/20, black, locked	1000	258	186	290	822	16,2	40760
Type 020 with Ductile iron grating 2 x 85/20, black, locked	1000	252	236	366	822	16,8	40761

RECYFIX® PLUS

RECYFIX® STANDARD

SLOTTED CAHNNELS

FASERFIX® STANDARD

RECYFIX® POINT  
FASERFIX® POINT

DACHFIX®

RECYFIX® GREEN SUPER

RECYFIX® GREEN STANDARD

RECYFIX® STREIF

LINEFIX®



# RECYFIX® PLUS 200

## RECYFIX® PLUS 200 - Accessories

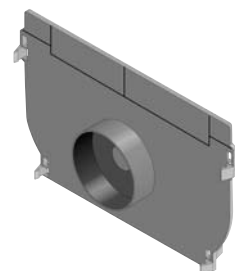
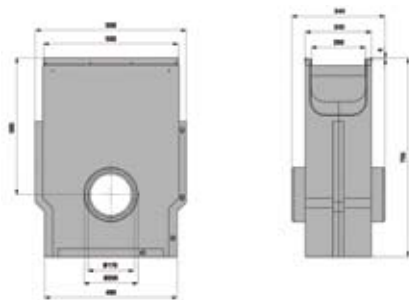

Trash box with ductile iron grating SW 2 x 85/20, black, cl. C 250, locked

End cap combined made of PE-PP with outlet DN 70, Type 010



Foul air trap, vertical, DN 100

	Length mm	Width mm	Height mm	Weight kg	Article No.
Trash box with mesh grating MW 30/30, galvanised, cl. B 125, locked	500	248	735	27,6	40756
Trash box with mesh grating MW 30/10, galvanised, cl. B 125, locked	500	248	735	29,2	40757
Trash box with GUGI-ductile iron grating MW 20/30, black, cl. C 250, locked	500	248	735	31,4	40753
Trash box with ductile iron grating SW 2 x 85/20, black, cl. C 250, locked	500	248	735	31,2	40754
Foul air trap, vertical, DN 100	-	-	-	0,5	40295
End cap combined made of PE-PP with outlet DN 70, Type 010	-	258	185	0,2	40692
End cap closed, Type 01	-	260	275	0,9	12081
Drilling of connecting holes DN 200	-	-	-	-	974
Cutting to length of NW 200	-	-	-	-	992
Sealing material SikaBond TS Fast, 600 ml, tubular bag, black	-	-	-	0,6	6890
Tubular pistol for Sikaflex TS Fast	-	-	-	1,3	6891

**RECYFIX®  
PLUS**

**RECYFIX®  
STANDARD**

**SLOTTED  
CHANNELS**

**FASERFIX®  
STANDARD**

**RECYFIX®POINT  
FASERFIX®POINT**

**DACHFIX®**

**RECYFIX®  
GREEN SUPER**

**RECYFIX®  
GREEN STANDARD**

**RECYFIX®  
STREIF**

**LINEFIX®**

# RECYFIX® PLUS 300

## RECYFIX® PLUS 300 - Combi article, class C 250

Type 01 with GUGI-ductile iron mesh grating, locked

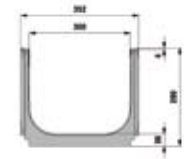
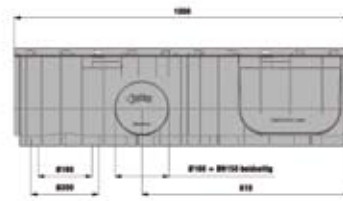
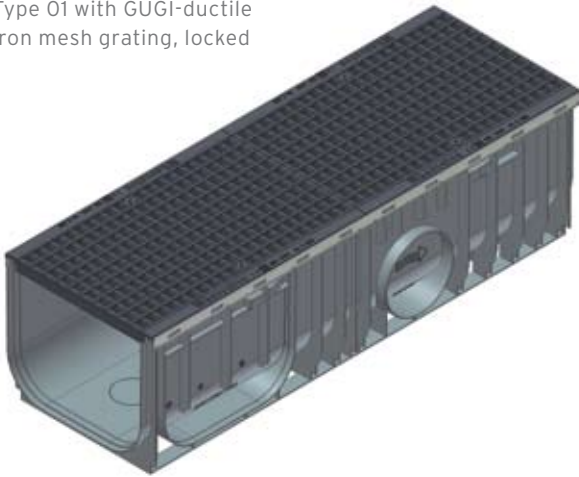

	Length mm	Width mm	Height mm	Drainage cross- sect. cm <sup>2</sup>	Intake cross- sect. cm <sup>2</sup> /m	Weight kg	Article No.
Type 01 with GUGI-ductile iron mesh grating, locked	1000	352	290	857	1327	30,1	41970